



Motorcycles

— in a class of their own



on every road

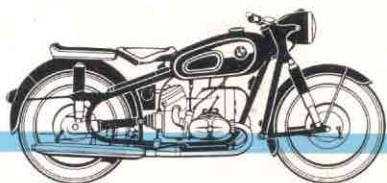
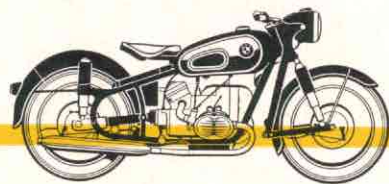
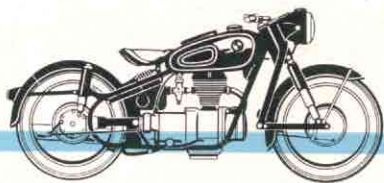

- in every town - in every country

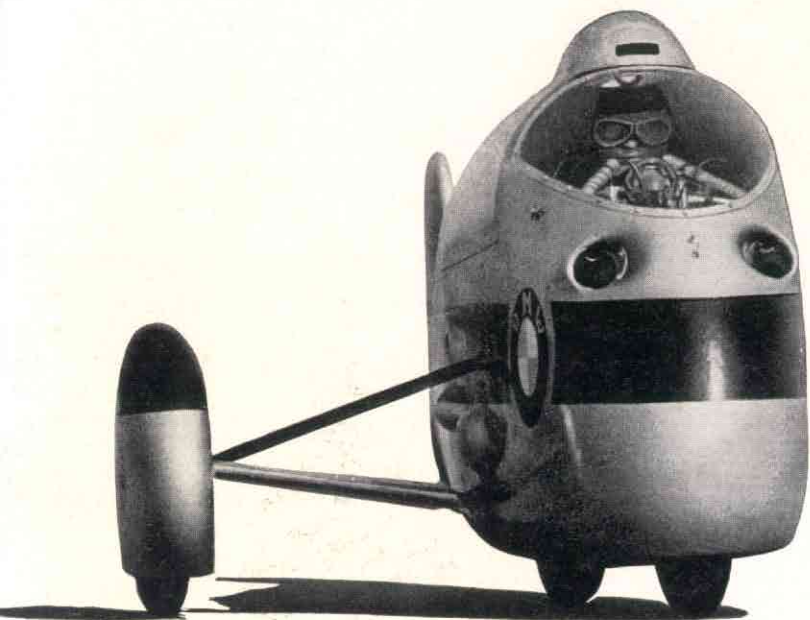

*F*astidious riders appreciate the value of fine technical details, knowing that the outstanding achievements in the field of motorcycling are linked with the latest engineering developments. The modern motorcycle combines sporting performance with the requirements of reliable everyday transport. The never ceasing developments resulting in new and improved models are the beacons in a world of progress and advancement. They are stimulating topics for comparison against a perspective of established achievements. Numerous refinements account for enhanced performance and the best of modern craftsmanship ensures unsurpassed quality.

The majority of designers, engineers, technicians and craftsmen engaged on producing BMW motorcycles, have invariably been associated with the manufacture of the famous BMW aircraft engines. The basic rule of the aircraft industry "Performance, Safety and Quality" applied to the manufacturing techniques employed in the production of BMW motorcycles has added to the fame and reputation of the make. Backed by valuable experiences, traditional skill and unique precision production facilities, a never ceasing stream of superb motorcycles has left the BMW factory during the past decades.

All over the world the BMW motorcycle, with the distinctive blue and white badge on the tank has been acclaimed by experts. — and their opinion is summed up in four words:

BMW — craftsmanship commands success!

The basic design of the BMW twin-cylinder motorcycle, has outpaced the dictates of style and fashion. Already the very first BMW motorcycle produced in 1923 was powered by a transverse mounted horizontal opposed twin-cylinder engine, with a gearbox in unit-construction and equipped with a cardan shaft rear wheel drive. The fundamental principles of this design soon proved their values and never ceasing scientific research coupled with a policy of methodical development has secured for BMW the lead in acknowledged technical perfection. All BMW motorcycles are now equipped with the race bred bottom-link front fork and spring frame. The modified location of the carburetors ensures an even more comfortable leg position and has made instantaneous starting from cold possible. The re-designed four speed gearbox incorporating a torsional vibration damper improves still further the already smooth performance. The famous characteristics of the BMW engines, — rapid acceleration, — the smooth surge of power, have been retained in the new models. Whether it is a single or twin-cylinder model, or the powerful R 69 sports model, — the sparkling performance developed by BMW engines permits acceleration in top gear from 12 mph to the maximum speed. An ample reserve of engine power ensures effortless high cruising speeds, enhanced by unsurpassed road-holding, — will satisfy the most fastidious rider and commands a pride of ownership. BMW motorcycles far ahead of contemporary designs, in quality the best modern craftsmanship can produce, — maintain the lead wherever motorcycles are ridden.

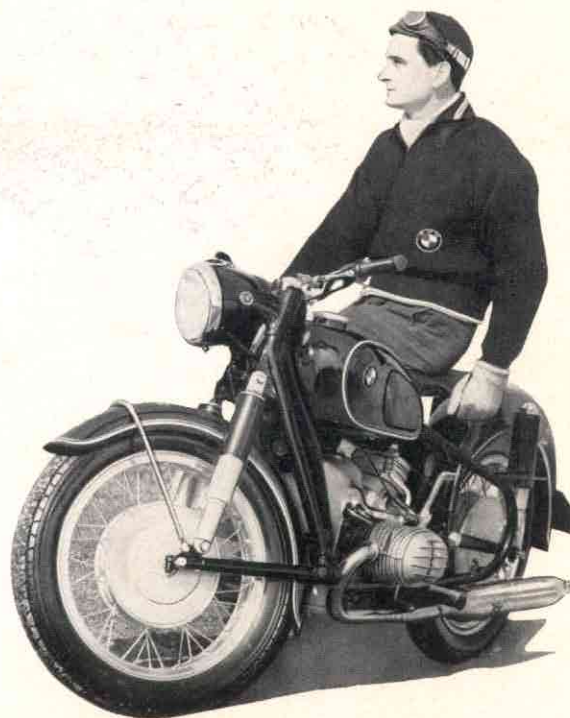



TOURING-SPORTS MODEL · 250 c. c. · 15 HP
with bottom-link fork and spring frame

The latest development of famous model, upholding the reputation which has made the 250 c.c. BMW a favourite with experienced riders in all parts of the world. Lively, superb to handle, this model satisfies the demands where inexpensive

daily transport, plus a standard of comfort and sporting performance is required.

The bottom-link fork and the race bred spring frame, equipped with suspension units incorporating hydraulic telescopic shock absorbers to ensure a riding comfort and road-holding characteristics hitherto never made available in any 250 c.c. motorcycle. In engineering details and in quality, the BMW R 26 has all the features of the larger BMW motorcycles. The reliable 250 c.c. engine now developing 15 H.P., is the latest version of a power-unit originally introduced in 1926. The sparkling performances of this classic single cylinder engine ensures incomparable pleasure, and thousands of miles of perfect service. The engine and four speed gearbox are of unit construction and the smooth transmission of power is still further enhanced by the rubber-cushioned cardan shaft drive totally enclosed within the right arm of the rear suspension. The BMW R 26 is sufficiently powerful for sidecar-work, — just one more reason why this model is regarded to be the most perfect 250 c.c. motorcycle produced anywhere in the world.

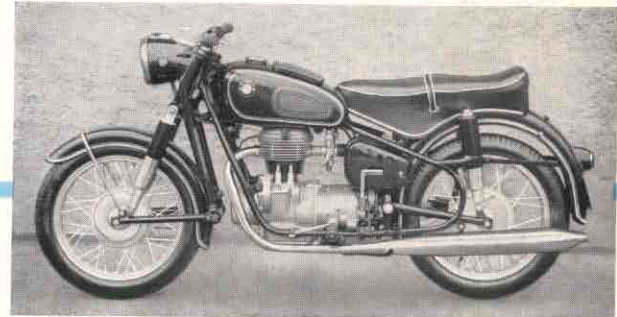
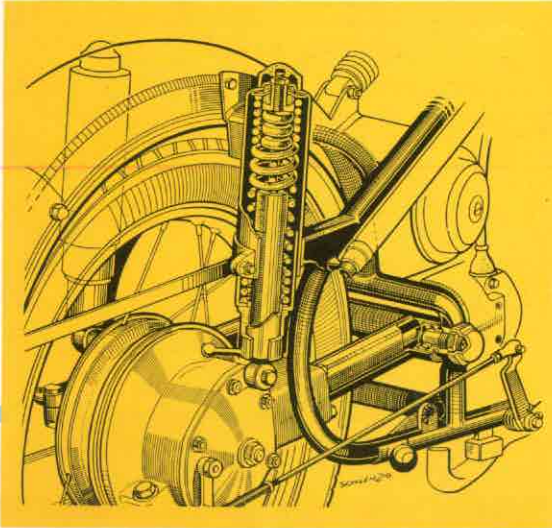

BMW

R 26

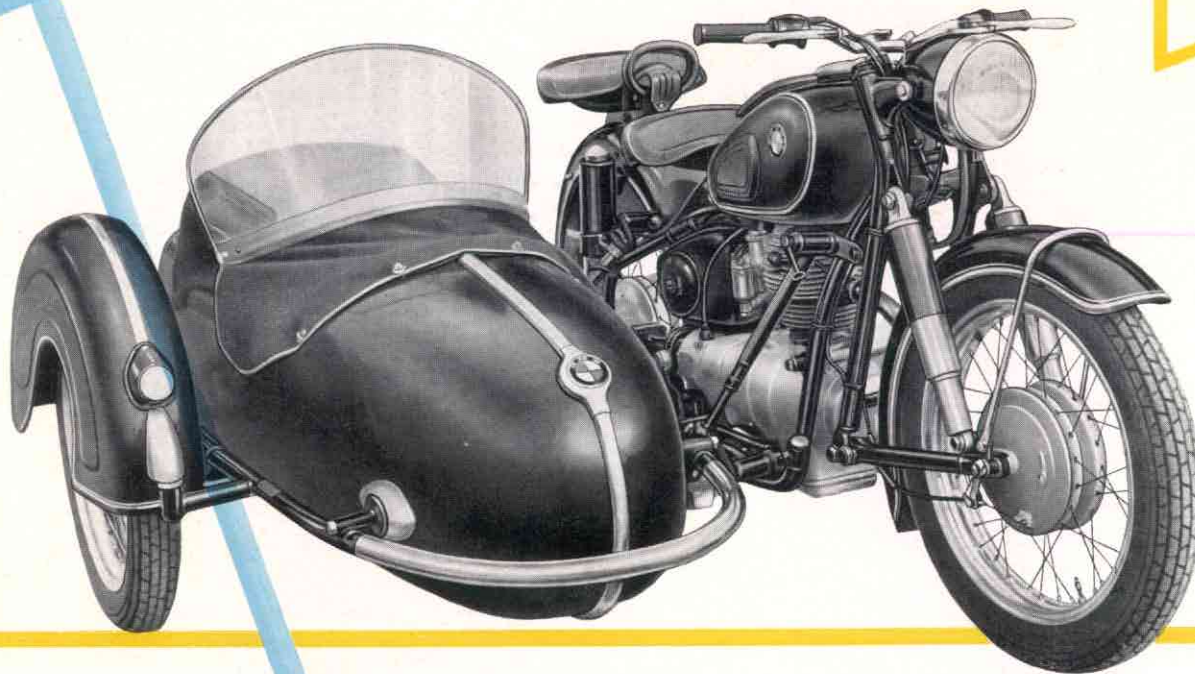

TOURING-SPORTS MODEL · 250 c. c. · 15 HP
with BMW "Standard" sidecar

Important details: Powerful single cylinder BMW engine, large capacity air-intake silencer and filter, four speed gear-box with positive foot-change, rubber-cushioned cardan shaft

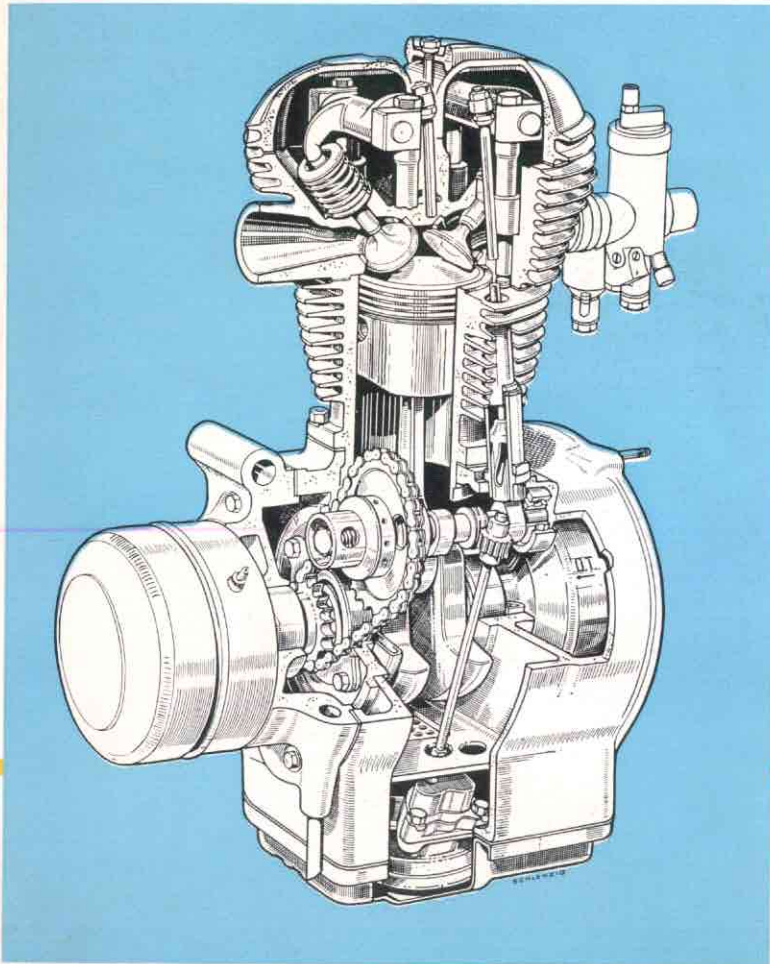

rear wheel drive, hydraulic damped front fork and rear suspension. The exceptionally strong spring frame, with dual down tubes, reinforced by a machined steering head and ample dimensioned frame lugs have been designed for sidecar work. Ball and socket joints are employed for the attachment of the sidecar.

The large and comfortable cantilever-sprung saddle completes the numerous refinements apart from: knock-out spindles for front and rear wheel which are also interchangeable, polished 18 inch light-alloy rims, full width hubs with large diameter brakes, combined rear and stoplight.

The BMW "Standard" sidecar, finished in high gloss ebony black has chromium plated decorative strips and apart from being equipped with a rubber suspension for the body and an independent wheel suspension, the hub of the sidecar wheel incorporates a large diameter hydraulic brake. The sidecar has a theft-proof luggage compartment, a plastic windshield and a weather-proof dust-apron. The BMW R26 complete with BMW "Standard" sidecar, offers economic and reliable transport for three people. The complete sidecar outfit has an overall length of 90 $\frac{1}{2}$ inches, an overall width of 59 $\frac{1}{2}$ inches and a total weight of 518 lbs, the weight of the sidecar being 163 lbs and the permissible load 187 lbs.



The new pivoted bottom-link fork has a large suspension movement and hydraulic shock absorbers. Ensuring positive hair-line steering and unsurpassed riding comfort.

The rubber-mounted sports type handlebars are fully adjustable and the steering head is equipped with a theft-proof lock.

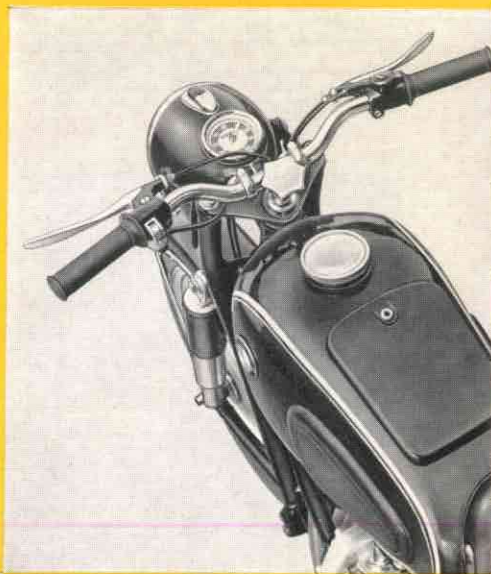

The well proportioned fuel tank has a capacity of 3.2 Imp. gal. or 3.9 U. S. gal. and incorporates a theft-proof locker for a selected kit of quality tools.



The outstanding performance of the
BMW R 26 whether ridden solo or with a
sidecar, has been acclaimed
all over the world.

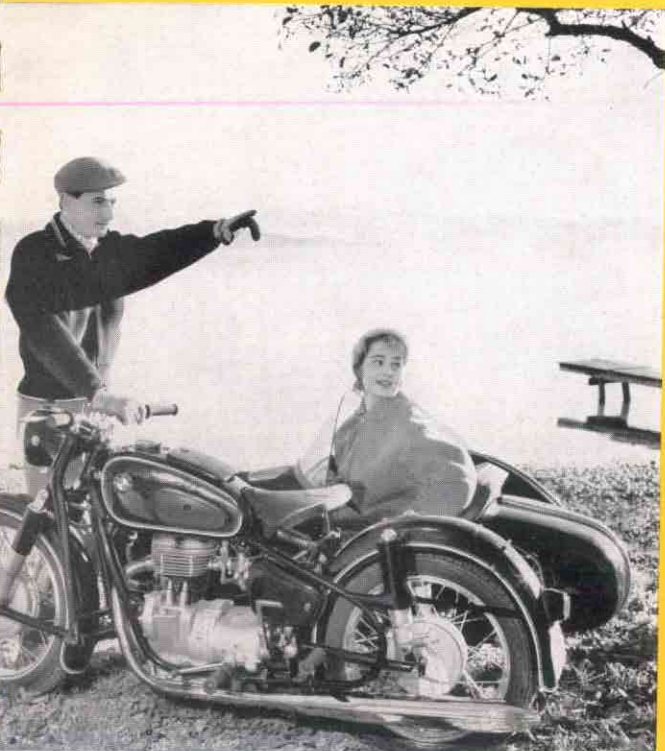
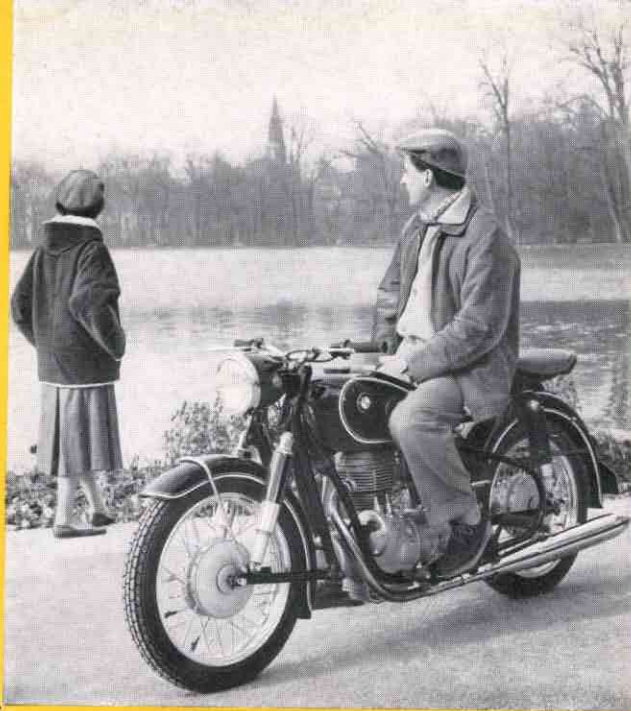

The 250 c. c. BMW motorcycle leads in technical design. Ample reserves of engine power make high cruising speeds possible. Equally at home in city traffic with plenty acceleration to spare, — the BMW R 26 is the ideal touring machine for any journey. With regards to performance, technical specification and quality, this 250 c. c. motorcycle is in a class of its own.

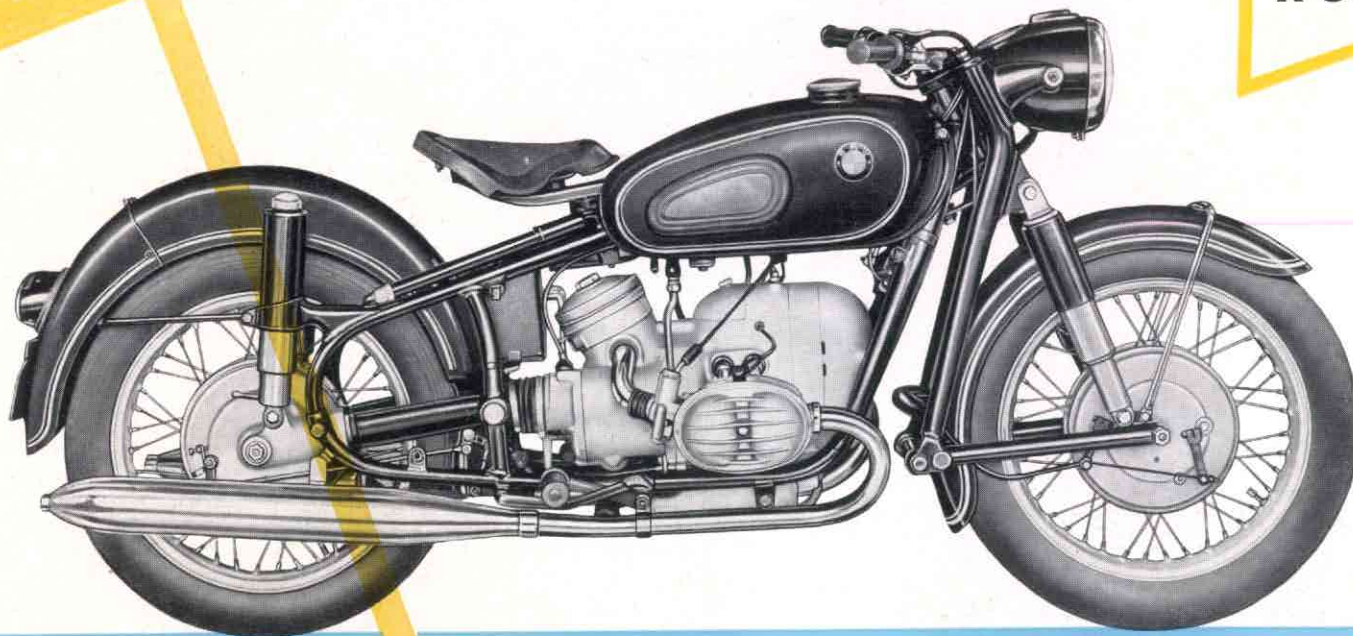

TOURING SPORTS MODEL • 500 c. c. • 26 HP
with bottom-link fork and spring frame

Never before have road-holding and riding characteristics been more precisely formulated than to-day. A motorcycle is expected to ride the road as smoothly as if it was

running on imaginary rails. No longer does one expect to steer with physical effort a motorcycle into a bend,— it is also no longer expected that one diverts from the intended track and when heeling over in a bend, momentary acceleration so often necessary must in no way adversely influence road-holding. Such stringent requirements seldom to be found are matter-of-fact characteristics in BMW motorcycles.

Superb steering and road-holding characteristics cannot be achieved unless springing and the movement of the wheel suspensions conform to specific details which are ensuring stability at any speed, on any surface. An adequate suspension movement, efficiently damped and an independent adjustment for the front and rear suspension are just some points to which BMW designers and technicians have paid particular attention. While already an adjustment for the suspensions plays an important part when riding solo or with a pillion passenger, the correct adjustment of the castor angle of the front wheel is important when using a sidecar. Even this detail has been realized in BMW motorcycles.

The race bred BMW brakes are a much envied achievement. They combine all those requirements which make any speed safe. Even a light application ensures uniform braking and the efficiency of BMW brakes does not change even under the toughest conditions.

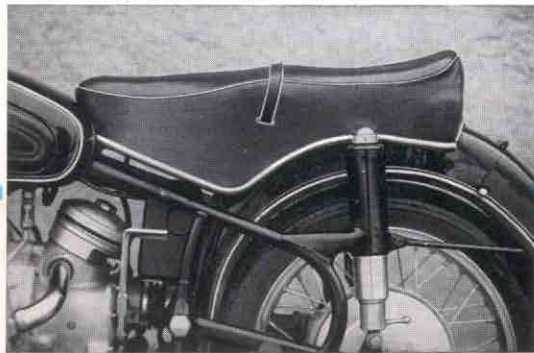

*A dual seat is available
on request*

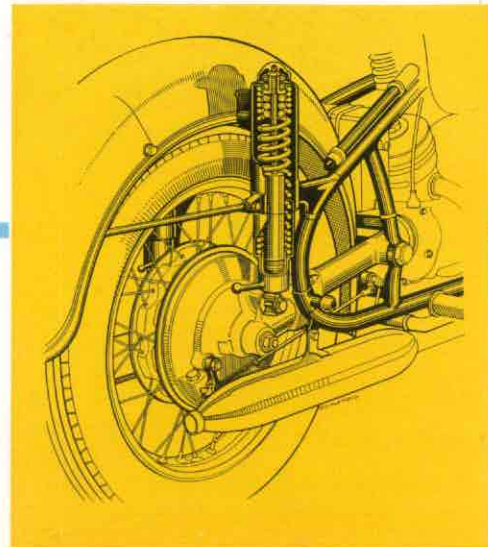

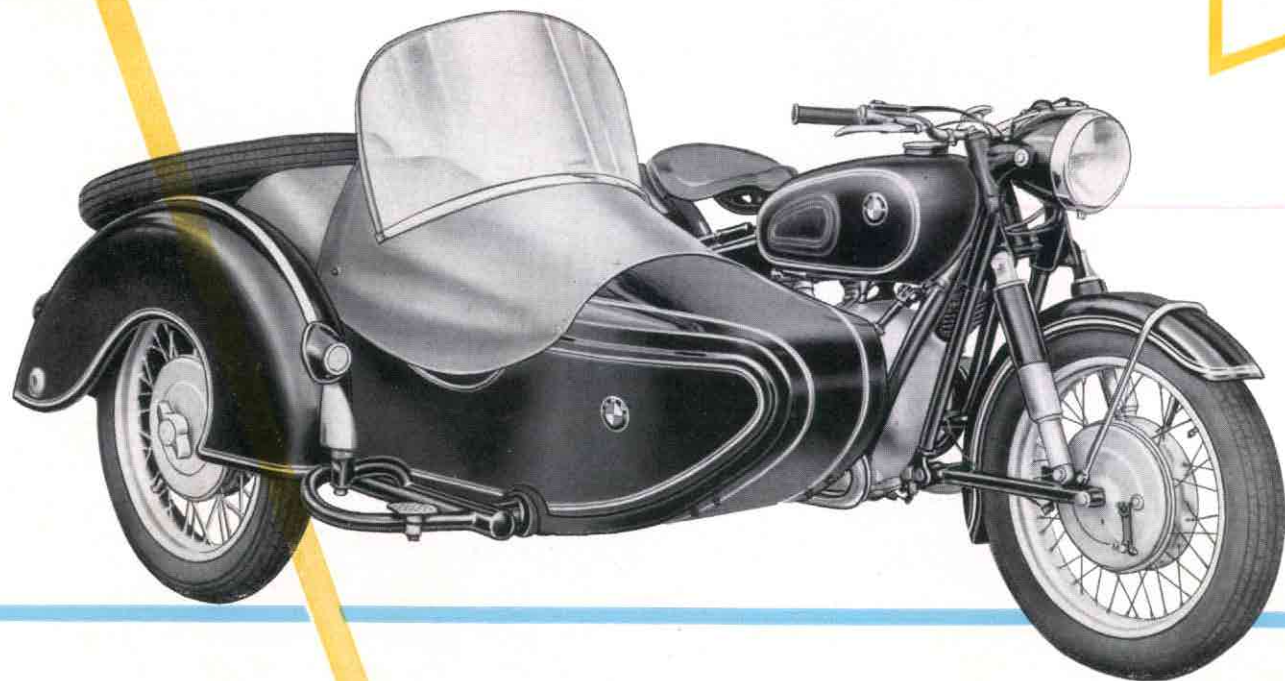
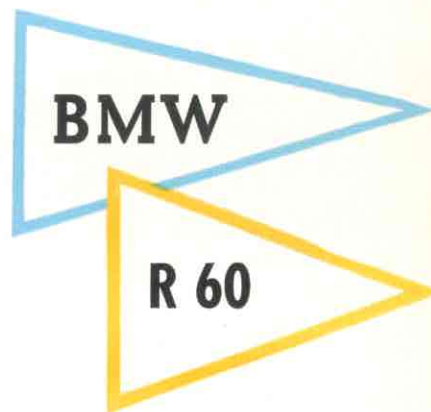

TOURING SPORTS MODEL · 600 c.c. · 28 HP
with bottom-link fork, spring fork and BMW "Spezial" sidecar

Intended for heavy-duty sidecar work the BMW R 60 has a powerful 600 c. c. horizontally opposed overhead-valve twin cylinder engine. The bottom-link fork and the spring frame ensure thousands of miles of perfect service.

The BMW "Spezial" sidecar has a rubber-mounted body, a trailing arm independent wheel suspension and is equipped with a hydraulic brake. The master-cylinder of the hydraulic brake system is actuated by the rear wheel brake pedal. For very heavy duty work an additional hydraulic telescopic shock absorber can be fitted to the suspension of the sidecar. The spacious sidecar body is equipped with a comfortable upholstered seat, a plastic windshield, a weather-proof dust-apron, a theft-proof luggage compartment and a spare wheel carrier complete with spare wheel. The BMW R 60 sidecar outfit has an overall length of 92⁵/₈ inches, an overall width of 63 inches and a kerb weight of 705 lbs, the weight of the sidecar being 264 lbs and the permissible load 275 lbs.

The pivoted bottom-link front fork and the hydraulic rear suspension of the R 60, have resulted from developments over the last three decades. Their reliability has been testified in many tough cross-country trials. Police and frontier forces, forestry services, customs and public authorities all over the world are using this powerful 600 c. c. BMW motorcycle.

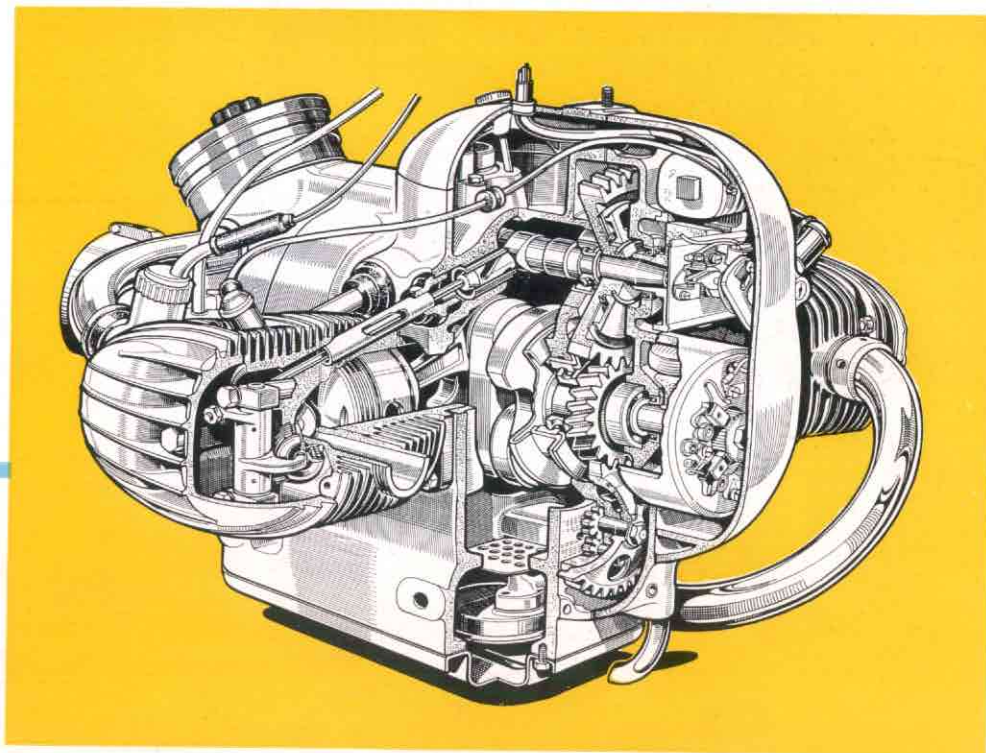

The definition "a minimum of vibration" must not be mistaken to mean, — a complete absence of vibration. The BMW twin-cylinder engine has always been regarded as the most perfect balanced power-unit fitted to any motorcycle. Experts who have carried out every conceivable test, — are unanimous in expressing the opinion, that there is practically a complete absence of vibration in the BMW engine. The transverse positioned cylinders are continuously swept by an ample supply of air, ensuring perfect cooling and eliminating therefore any possibilities of overheating or the distortion of cylinder or cylinder heads. This highly efficient method of cooling offers still more advantages; sustained high cruising speeds will do no harm to the amazing powerful engine, whose fuel consumption always remains at an economic level! There is no other engine design, including parallel twin-cylinder or V-engines which can offer those superb advantages. The BMW engine and gearbox are a single unit, and the transmission of power to the foot operated four-speed gearbox via a large diameter single-plate clutch and finally through a rubber-cushioned cardan shaft to the bevel gear drive of the rear wheel, is similar to the method of power transmission employed in automobile engineering. BMW have pioneered this method of transmission in the motorcycle field and are still leading in design. The very compact construction of the power-unit makes an ideal low centre of gravity possible. The pivoted bottom-link front fork with the large size suspension units incorporating hydraulic tele-

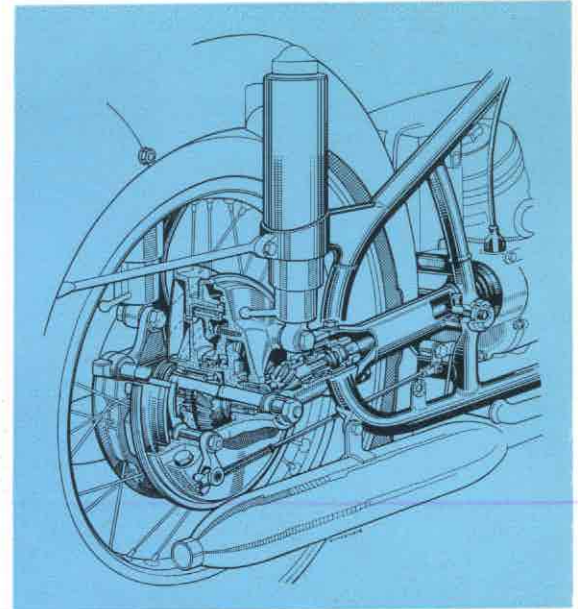

scopic shock absorbers, the spring frame with the adjustable hydraulic suspension units, are developments which have only been made possible by gathering the valuable experiences obtained with BMW world record and racing machines. Rapid acceleration, — the surge of

power, — smooth and efficient brakes, — positive hair-line steering and unsurpassed road-holding characteristics, — have made BMW motorcycles famous all over the world.

BMW

the fastest German production motorcycle

R 69

Freie Fahrt
OPEN DRIVE

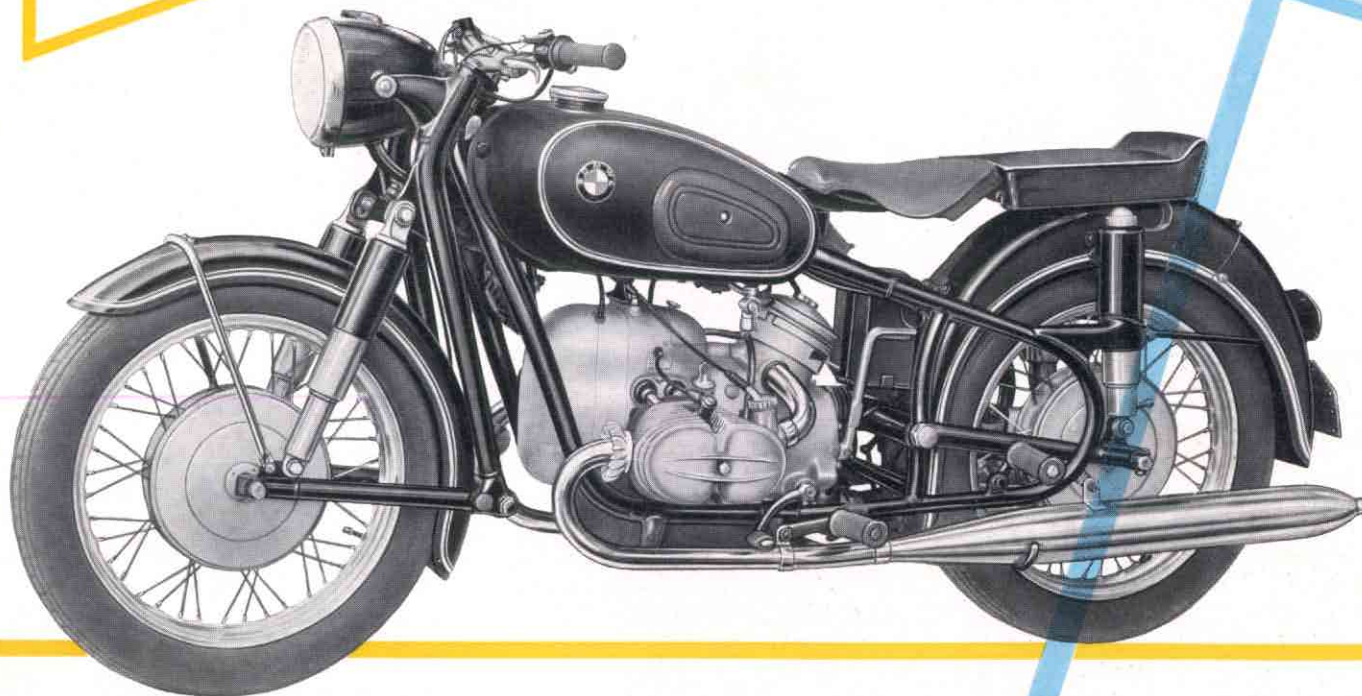

SPORTS MODEL • 600 c.c. • 35 HP
with bottom-link fork and spring frame

Specifications

We reserve
the right to modify
or deviate from
the printed specifications
and details

Brake horsepower	15
Number of cylinders	one
Cylinder capacity	245 c.c.
Bore	2.67 in. (68 mm)
Stroke	2.67 in. (68 mm)
R. p. m.	6400
Compression ratio	7.5 : 1
Lighting system	6 V/60 W
Carburettor	Bing 1/26
Gear ratios	
First	5.33 : 1
Second	3.02 : 1
Third	2.04 : 1
Top	1.54 : 1
Rear wheel drive, ratio of bevel gear	
Solo	4.16 : 1
Sidecar	5.2 : 1
Fuel tank capacity	3.29 Imp. gal. 3.96 U.S. gal.
Fuel consumption	
Solo	85 Miles/Imp. gal. 71 Miles/U.S. gal.
Sidecar	74 Miles/Imp. gal. 61 Miles/U.S. gal.
Max. Speed, solo	80 m.p.h.
Kerb weight, solo	345 lbs. (158 kg)
Tyres	3.25 x 18
Overall length	82 1/4 in.
Overall width	26 in.
Saddle height	30 1/4 in.

R 26

R 50

26
two (opposed)
490 c.c.
2.67 in. (68 mm)
2.67 in. (68 mm)
5800
6,8:1
6 V/60-90 W
Bing 1/24/45/46

5.33:1
3.02:1
2.04:1
1.54:1

3.18:1
4.33:1
3.73 Imp. gal.
4.49 U.S. gal.

70 Miles/Imp. gal.
58 Miles/U.S. gal.
53 Miles/Imp. gal.
44 Miles/U.S. gal.
87 m.p.h.
418 lbs. (195 kg)
3.50 x 19

83½ in.
26 in.
28½ in.

28
two (opposed)
590 c.c.
2.83 in. (72 mm)
2.87 in. (73 mm)
5600
6.5:1
6 V/60-90 W
Bing 1/24/95/96

5.33:1
3.02:1
2.04:1
1.54:1

2.91:1
3.86:1
3.73 Imp. gal.
4.49 U.S. gal.

^{Solo}
67 Miles/Imp. gal.
56 Miles/U.S. gal.

^{Sidecar}
50 Miles/Imp. gal.
42 Miles/U.S. gal.

90 m.p.h. with 3 people 69 m.p.h.
428 lbs. (195 kg) 705 lbs. (320 kg)
front 3.5 x 18 front 3.5 x 18
rear 3.5 x 18 rear 4.0 x 18
83¾ in. 94 in.
26 in. 63¾ in.
28½ in. 28½ in.

R 60

R 69

35
two (opposed)
590 c.c.
2.83 in. (72 mm)
2.87 in. (73 mm)
6800
8.0:1
6 V/60-90 W
Bing 1/26/9/10

5.33:1
3.02:1
2.04:1
1.54:1

3.18:1
4.33:1
3.73 Imp. gal.
4.49 U.S. gal.

72 Miles/Imp. gal.
60 Miles/U.S. gal.

103 m.p.h.
444 lbs. (202 kg)
front 3.50 x 18
rear 3.50 x 18
83½ in.
28½ in.
29 in.



A special high precision cylinder boring machine.

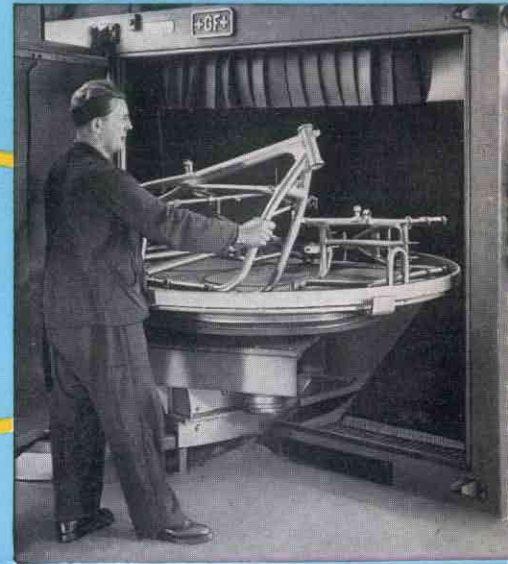

Modern sand blasting equipment ensures a good paint finish.



Rear wheel drive bevel gears are inspected with special gauges.



The modern final assembly line.



Packing for dispatch to all parts of the world.



Skilled craftsmen assemble the powerful engines.

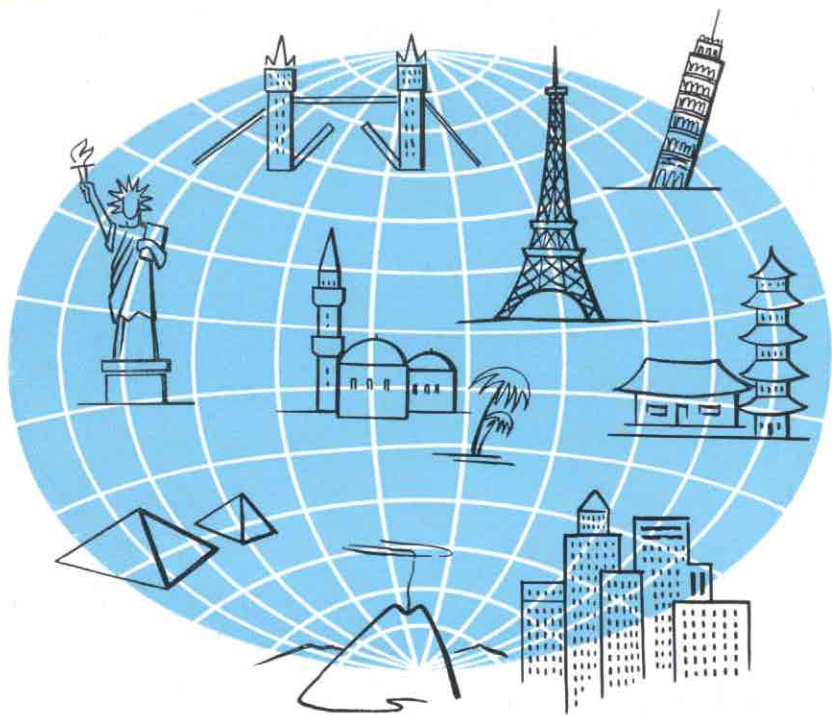

BMW *all over the world*



B On the
sun drenched roads of Indonesia
BMW motorcycles are
no longer a rarity.



S Popular in Sweden
BMW motorcycles are much admired
for safe and easy handling.

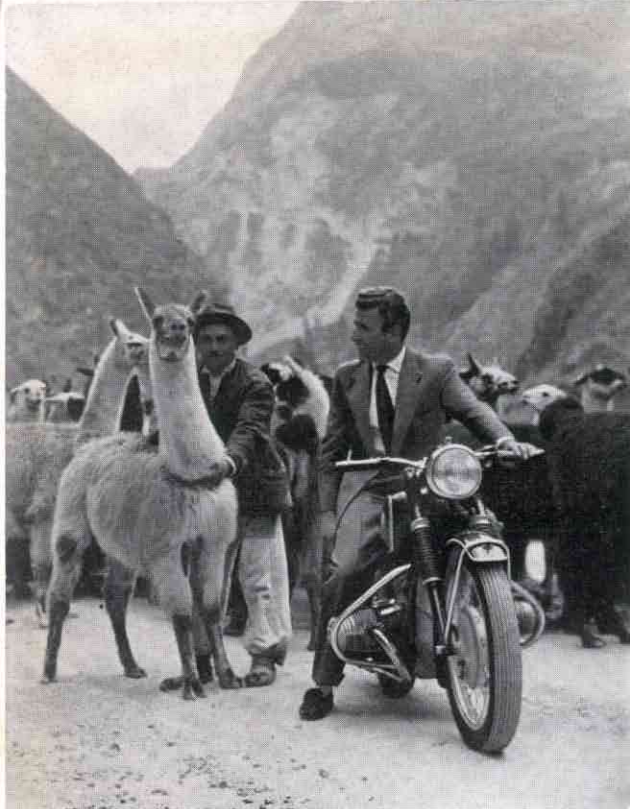

*On a mountain road leading
over the Andes in Peru.*

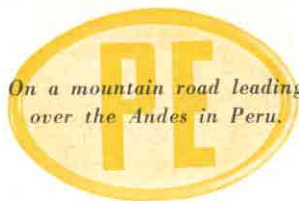

*BMW motorcycles
escort the "Gigants of the Road"
in the "Tour de France".*

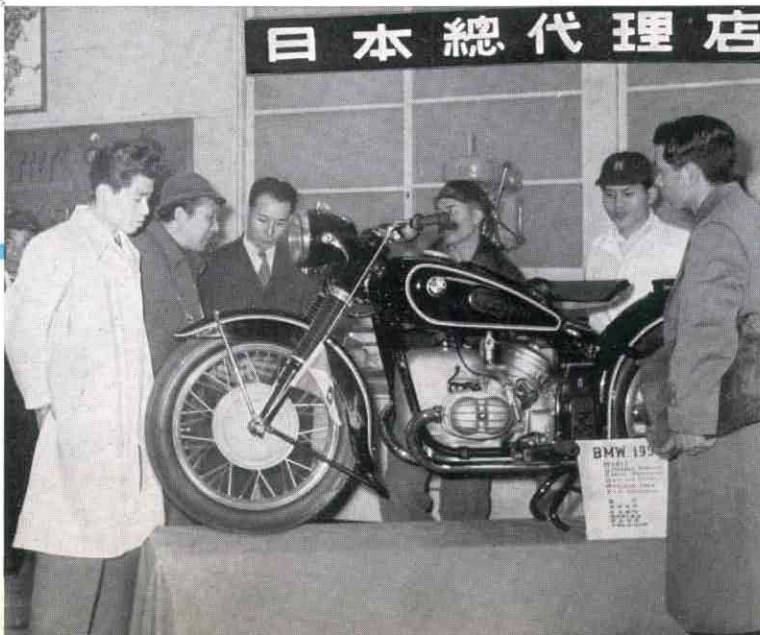

*Much admired at motorcycle show
in the Far East.*





*BMW has scored many victories
in Australian sport and racing events.*



*A South African
BMW rider follows the call
of the desert.*

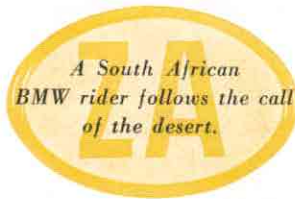

*Mexico is one of the 88 countries
to which BMW motorcycles are exported.*





World Championship
Manufacturers World Championship
92 World Speed Records
British Tourist Trophy – First Place in 500 c.c. sidecar class
6 World Speed Records in the 500 c.c. solo class

1956 – ONCE MORE A SUCCESSFUL YEAR FOR BMW:

Solo Class: German Championship • Austrian Championship • Grand Prix of Czecho-Slovakia • Wiener Höhenstraßen Races • Sachsenring Races • Norisring Races • Circuit Races Budapest • Circuit Races Salzburg
T. T. Bathurst, Australia

Sidecar Class: German Championship • Grand Prix of Belgium • French Championship • Grand Prix of Saar
Grand Prix of Holland • Grand Prix of Germany • Grand Prix of Ireland • Sachsenring Races
Hockenheimring Races • Norisring Races • Circuit Races Salzburg
International Avus Races

S u c c e s s i n R a c i n g · Q u a l i t y i n P r o d u c t i o n



Crowning all the racing victories which BMW was able to achieve on circuits in every part of the world, — Wilhelm Noll and Fritz Cron won for BMW — for the third time as from 1954 — the

WORLD CHAMPIONSHIP



GERMAN ROAD RACING CHAMPIONSHIP

500 c.c. Solo Class : *Ernst Riedelbauch*

Hillebrand/Grunwald – successful on many circuits.



The BMW racing outfit of Schneider/Strauss being prepared for the start at Monza.



Noll/Cron calmly waiting for the start for the final 1956 World Championship run.





*Walter Zeller, – won the German
Championship 1954 and 1955 on
BMW*



*Walter Zeller, – demonstrating
his riding technique.*

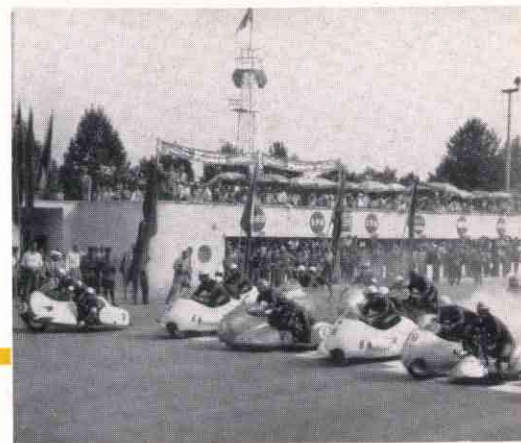

*Start of the 500 c.c. sidecar class for the final
World Championship run at Monza.*

GERMAN ROAD RACING CHAMPIONSHIP

500 c.c. Sidecar Class : Wilhelm Noll/Fritz Cron



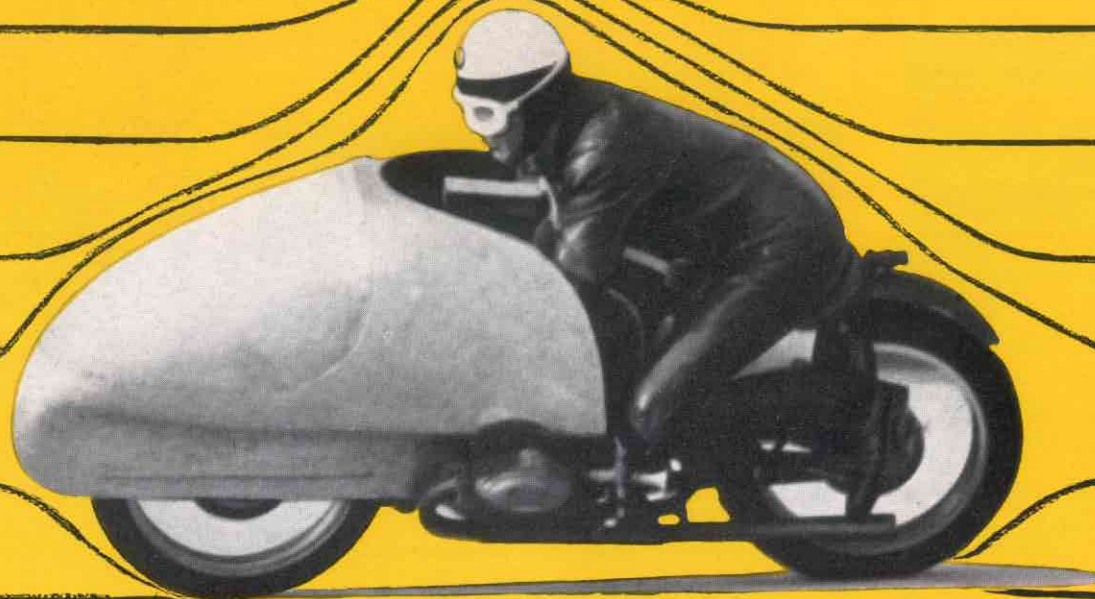

WORLD SPEED RECORDS and racing victories are the basis of development in the field of the motorcycle.

BMW holds in the 500, 750 and 1000 c. c. solo class

6 WORLD RECORDS :

10 Kilometers with standing start = 233 km/h

10 Miles with standing start = 242 km/h

s. s. = standing start f. s. = flying start



BMW holds in the 500, 750 and 1200 c. c. sidecar class

92 WORLD SPEED RECORDS

*1 Km	f. s. 280.2 km/h	100 Miles	s. s. 170.5 km/h	3 Hours	s. s. 161.0 km/h
1 Km	s. s. 139.3 km/h	500 Km	s. s. 160.7 km/h	4 Hours	s. s. 159.7 km/h
5 Km	f. s. 271.4 km/h	500 Miles	s. s. 156.7 km/h	5 Hours	s. s. 156.6 km/h
*1 Mile	f. s. 280.2 km/h	1000 Km	s. s. 155.1 km/h	6 Hours	s. s. 156.1 km/h
1 Mile	s. s. 165.7 km/h	1000 Miles	s. s. 151.7 km/h	7 Hours	s. s. 154.9 km/h
5 Miles	f. s. 266.7 km/h	2000 Km	s. s. 149.3 km/h	8 Hours	s. s. 154.2 km/h
10 Km	s. s. 212.7 km/h	**2000 Miles	s. s. 144.7 km/h	9 Hours	s. s. 153.5 km/h
10 Miles	s. s. 208.9 km/h	**3000 Km	s. s. 145.3 km/h	10 Hours	s. s. 152.3 km/h
50 Km	s. s. 185.0 km/h			11 Hours	s. s. 151.6 km/h
50 Miles	s. s. 181.3 km/h	1 Hour	s. s. 171.2 km/h	12 Hours	s. s. 150.5 km/h
100 km	s. s. 182.0 km/h	2 Hours	s. s. 162.0 km/h	24 Hours	s. s. 144.3 km/h

* only valid for the 500 and 750 cc. classes

** those world records do not exist yet in the 1200 c. c. class; as in October 1956

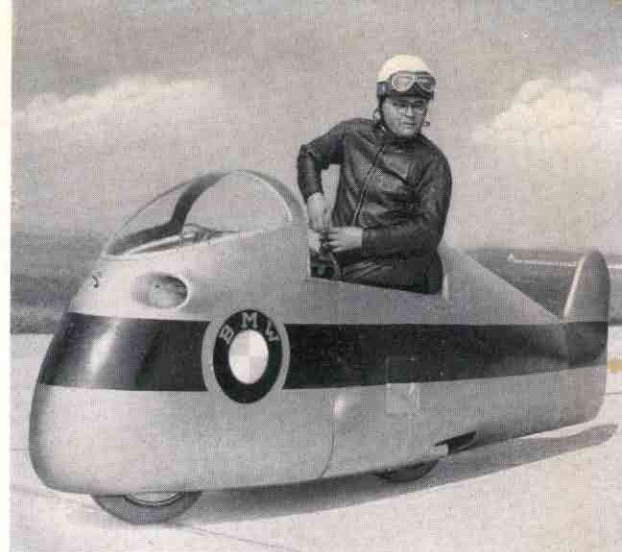

WITH A SPEED OF 280 km/h, BMW IS THE WORLDS FASTEST SIDECAR

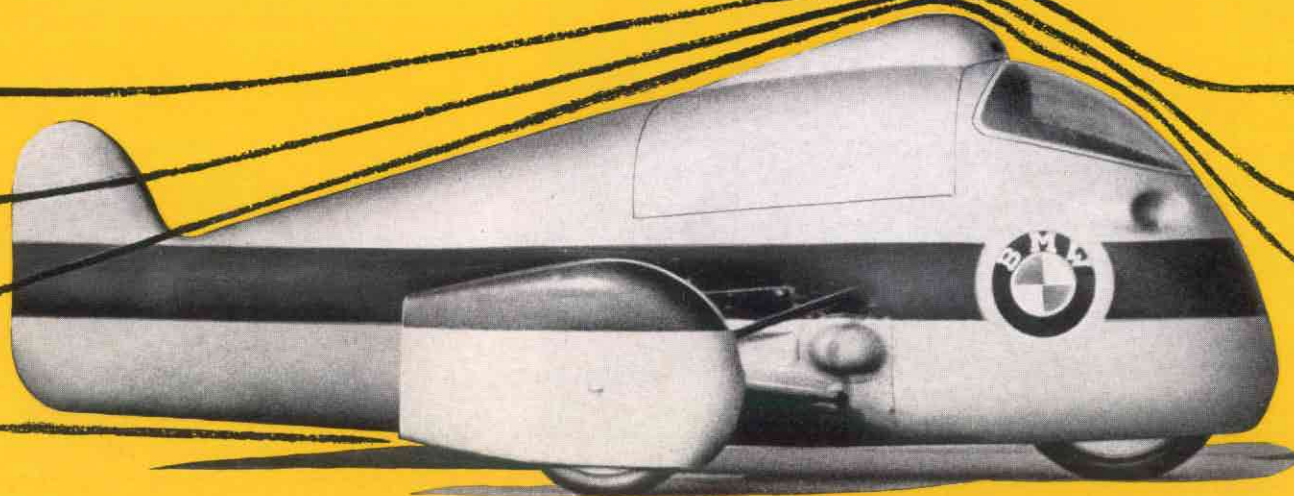



*Hans Meier
riding a BMW R 50*

Successful in Endurance Trials

*International Six Days Trial 1956
5 B.M.W.s started - 5 B.M.W.s finished
Big gold medal awarded by the F.I.M.*



*Sebastian Nachtmann
riding a BMW R 26*



*„Wiggerl“
Kraus/Prutting
competing
in a tough
endurance trial.*

The race-bred engine performance, the engineering skill employed during manufacture and finally the selected materials which are used in the production of BMW motorcycles have made it possible to achieve an unsurpassed standard of cross-country reliability. Whether in endurance trials or in tough cross-country events, — BMW is always in the lead.



Experts comment on BMW motorcycles:

George Wilson "The Motor Cycle" London

... some conclusions remain after the test:

The first one, that the BMW seemed to be undestructable. The second that this is a motorcycle produced without regards to costs, quality being the prime objective. The BMW is a wonderful example of what a motorcycle can be.

J. Birger "Moto-Revue" Paris

... the BMW R 25/3 is a very manoeuvrable machine, with excellent stability and a hydraulic telescopic front fork which ensures superb road-holding.

H. W. Boensch "Auto- und Motorradwelt" Cologne

... for more than two decades have the telescopic front forks of BMW machines been regarded as an outstanding achievement in the field of the motorcycle. As the results of the tests with the BMW R 50 and the even faster model R 69, I have every reason to assume that the excellent suspension characteristics of their leading-link fork will be unequalled in years to come.

J. F. Droksch "ADAC Motorwelt", Munich

... no other engine seems to be as smooth and silent as the one in the R 50, — yes, one could compare this power-unit with those used in many cars. This in itself is unique in the field of the motorcycle, but added to this even when the engine is developing its full surge of power, — there is a complete absence of noise from the gearbox.

... This is a unique motorcycle in every respect.

BMW motorcycles hold the lead in cross-country events



BMW

Service

in 88 countries

throughout the world

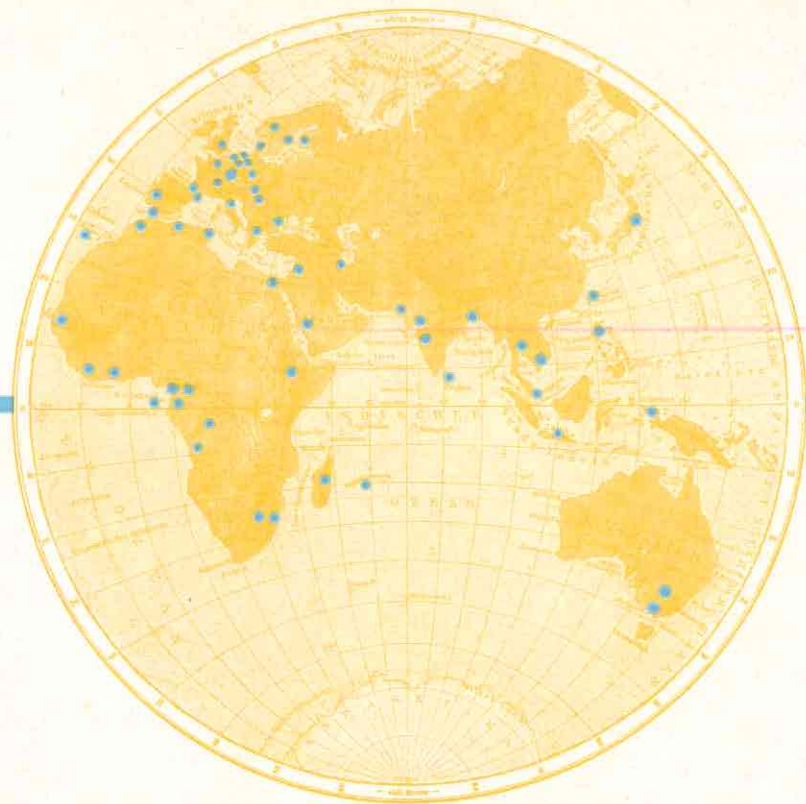

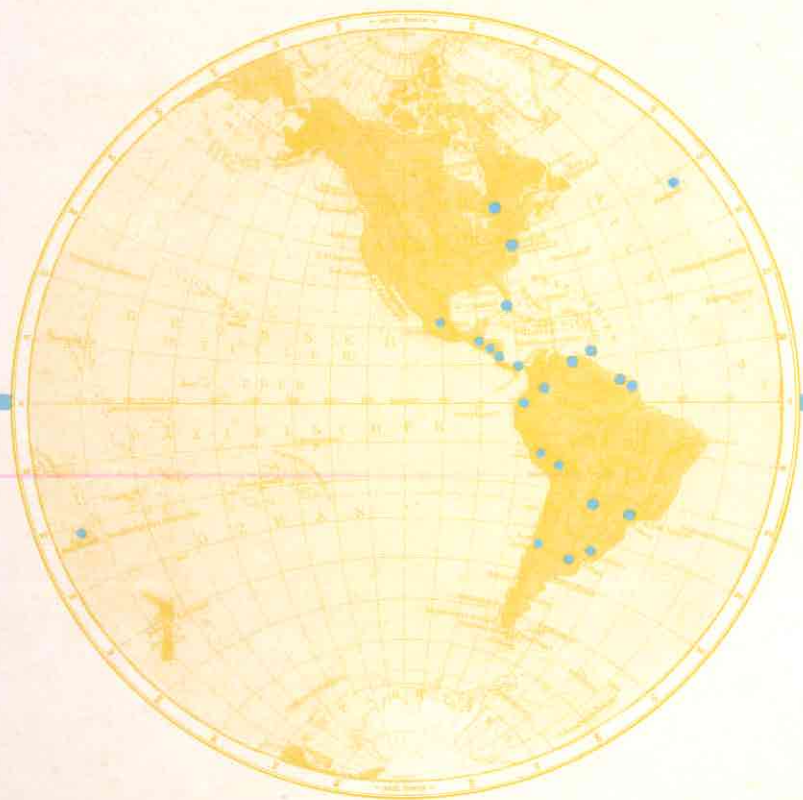

A world-wide BMW Service Organization staffed

by factory trained personnel is always ready to

render expert assistance. The BMW Dealer

maintains a continuously factory-supervised

stock of genuine spares and a fully equipped

workshop, he is well qualified to advise you.



DEALER:

BAYERISCHE MOTOREN WERKE AG MÜNCHEN